

# AVAPOW

Jump starter

-User Manual-

Model: A27 **EN**





---



**Friendly Tips:**

Please read carefully the instruction manual so that you can be familiar with the product more conveniently and quickly! Please use product correctly based on the instruction manual.

Perhaps there is small difference between the picture and the actual product, so please turn to the actual product for detail information.

---

## What's in the box

- AVAPOW jump starter x1
- Intelligent battery clamps with starter cable x1
- High quality type-C charging cable x1
- User-friendly manual x1
- Storage bag x1

## Specifications

Model number	A27
Capacity	84.36Wh
EC5 output	12V/2500A maximum starting power (max.)
USB1 output	5V/3A, 9V/2A, 12V/1.5A
USB2 output	5V/2.1A
Wireless charging output	5W/7.5W/10W MAX
Type-C input	5V/2A, 9V/2A
Micro input	5V/2A
Charging time	5-8 Hours
LED light power	White: 1W
Working temperature	-20 °C ~+60 °C / -4°F ~+140°F
Dimension (LxWxH)	209*107*56.4mm

## Product diagrams

- ❶ Power button
- ❷ USB1: 5V/3A, 9V/2A, 12V/1.5A
- ❸ USB2: 5V/2.1A
- ❹ Micro input: 5V/2A
- ❺ Type-C input: 5V/2A, 9V/2A
- ❻ LED display
- ❼ Wireless charging
- ❽ EC5 jump start output
- ❾ LED light
- ❿ Light button

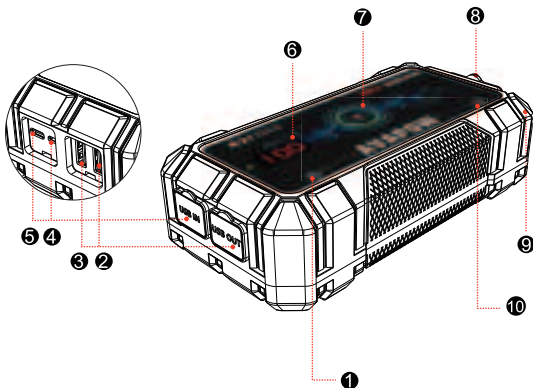

---

## Accessories



Intelligent battery clamps with starter cable



High quality type-C charging cable

## Charge the Jump Starter battery

### Charging with an AC adapter (**Note:AC adapter is not included**).

- 1.Connect the battery input with Type-C cable.
- 2.Connect the Type-C cable to AC adapter.
- 3.Plug the AC adapter into a power source.

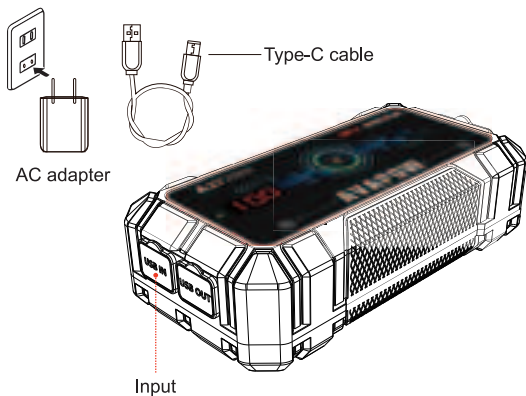

## LED display

Press the power button,the LED display shows as follows:



# How to Jump Start Your Vehicle



This unit is designed for jump starting 12V car batteries only and rated for gasoline engines up to 8 liters and diesel engines up to 8 liters. Do not attempt to jump start vehicles with a higher battery rating, or different voltage. If the vehicle isn't started immediately, please wait for 1 minute to allow device to cool down. Do not try to restart the vehicle after three consecutive attempts as this may damage the unit. Check your vehicle for other possible reasons why it can't be restarted.

## Operating instructions

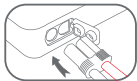

### First step:

Press the power button to turn on it, check the battery shown on the LED display, then plug jumper cable into battery pack outlet.

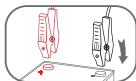

### Second step:

Connect the jumper clamp to car battery, red clamp to positive, black clamp to negative pole of car battery.

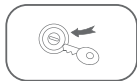

### Third step:



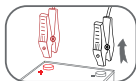





Turn on the car engine to start car.



### Fourth step:

Pull the plug of battery terminal from jump starter and remove clamps from auto battery.

## Jumper Clamp Indicator Instruction

Item	Technical parameters	Instruction
Input low voltage protection	14.0V±0.5V	When the power of the jump starter is too low, after connecting the starter and the car, the "  " symbol is on, the buzzer sounds once every 1 second, and the current voltage of the starter power is displayed.
Input high voltage protection	17.5V±0.5V	When the car voltage is too high, after connecting the starter and the car, the "  " character flashes and the buzzer beeps for a long time.
Reverse connection protection	Support	When the red/black clips of the wire clip is reversely connected to the car battery (battery voltage ≥0.8V), the "  " symbol is on, the "  " symbol flashes, the buzzer sounds once every 1 second.
Short circuit protection	Support	When the red and black clips are short-circuited in the standby state, the "  " symbol is on, the "  " symbol flashes, the buzzer sounds once every 1 second.
Multi-frequency protection	8 times	When start up to 8 times continuously, the "  " symbol flashes.
Work instruction	Support	When working normally, display the voltage of the current jump starter.
Standby instruction	Support	The "  " symbol circulate instructions from left to right.
Car battery voltage detection	Support	When the wire clip is only connected to the car battery (the car battery voltage needs to be ≥8V), the "  " symbol is on, and the current car battery voltage is displayed.



## How to charge a mobile phone or digital products?



With powerful capacity and two USB output ports (one is USB Quick Charge-5V/3A,9V/2A,12V/1.5A), it can full charge your smart phones and tablets up to 75% faster than a standard charger. It also provides wireless charging function (5W/7.5W/10W MAX), making it's more convenient to charge your wireless charging phones! You can charge three devices at the same time.

### Operating instructions:

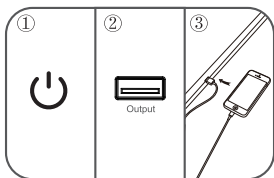

Press the power button—>connect the phone and power bank output port—>charging

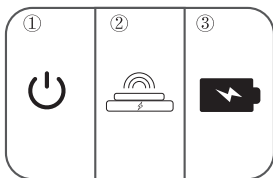

Press the power button—>put the phone on wireless charging area—>charging

## LED flashlight



Short press the Light Button to turn on the flashlight. The battery capacity indicator lights up. Short press the light button again to scroll through the lighting, Strobe, SOS. Short press again to turn off the flashlight. The flashlight offers more than 35 hours of continuous use when fully charged.

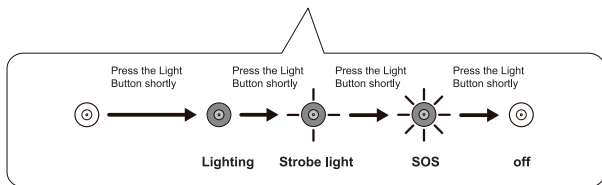



## Safety Warning

1. Never short circuit the jump starter by connecting the Red and Black clamps.
2. Do not disassemble the jump starter.
3. If you find swelling, leakage or odor, please stop using the jump starter immediately.
4. Please use this starter at normal temperature and keep away from humid, hot and fire places.
5. Do not start the vehicle continuously. There should be at least 30 seconds to 1 minute between two starts.
6. When the battery power is less than 10%, do not use the jump starter otherwise the device will be damaged.
7. Before first use please charge it for 3 hours or more.
8. If the positive clamp of the starting power was incorrectly connected to the negative poles of the car battery, the product comes with relevant protective measures to avoid personal injury and property damage.

### Note:

- For the first use, please make sure to fully charge before use.
- In normal use, please confirm that the unit has at least 50% power before use
- Wireless charging output is not supported with AC adapter

### Warranty Exemption

1. The product has been incorrectly operated or damaged due to the following irresistible reasons (such as flood, fire, earthquake, lightning, etc).
2. The product has been repaired, disassembled or modified by non-manufacturer or non-manufacturer authorized technicians.
3. The problem caused by wrong charger does not match the product.
4. Beyond the product warranty period (24-month).



## FCC Statement

Changes or modifications not expressly approved by the party responsible for compliance could void the user's authority to operate the equipment.

This equipment has been tested and found to comply with the limits for a Class B digital device, pursuant to Part 15 of the FCC Rules. These limits are designed to provide reasonable protection against harmful interference in a residential installation. This equipment generates uses and can radiate radio frequency energy and, if not installed and used in accordance with the instructions, may cause harmful interference to radio communications. However, there is no guarantee that interference will not occur in a particular installation. If this equipment does cause harmful interference to radio or television reception, which can be determined by turning the equipment off and on, the user is encouraged to try to correct the interference by one or more of the following measures:

- Reorient or relocate the receiving antenna.
- Increase the separation between the equipment and receiver.
- Connect the equipment into an outlet on a circuit different from that to which the receiver is connected.
- Consult the dealer or an experienced radio/TV technician for help

This device complies with part 15 of the FCC rules. Operation is subject to the following two conditions (1) this device may not cause harmful interference, and (2) this device must accept any interference received, including interference that may cause undesired operation.

